

## Design and Analysis of 7-DOF Vehicle Model

Manli Li

*School of Art and Design, Wuhan Polytechnic University, Wuhan, 430000, China*

### Abstract

*The dynamic load caused by vehicle-road coupling is the main cause of pavement damage, so the research on vehicle mode is the premise of the research on vehicle-road coupling. The current research is based on computer simulation or field test, but both of them have obvious shortcomings. In this paper, the vehicle model with seven degrees of freedom is designed and manufactured by using the method of model test. The parameters of vehicle model are determined by using the dimensional analysis method. The analysis of vehicle model mode is compared with the test results to verify that the designed 7-DOF vehicle model is reasonable.*

**Keywords:** 7-DOF vehicle model, modal analysis, inherent frequency

### I. Introduction

Since the reform and opening up, with the continuous growth of national vehicle ownership, the problem of vehicle damage to roads has gradually become a hot spot. The dynamic load caused by the vehicle-road coupling is the main cause of road surface damage, so the modal study of vehicle is the premise of studying the vehicle-road coupling dynamic load.

In foreign countries, modal research on vehicle models has been carried out very early, but up to now, there is no test method with high accuracy, simple operation, economic efficiency and practicality. An representative case is that Cebon et al. of Cambridge University in England developed the "wheel load test pad". The principle is that a large number of sensors are densely arranged in the suspension system of the automobile, which can conveniently test the vibration state of the vehicle during operation. The disadvantage is that it can only be tested for a single type of vehicle system<sup>[1-3]</sup>.

In China, Deng Xuejun, Fang Fusen<sup>[4]</sup> et al. first put forward the factors affecting dynamic load, such as vehicle vibration, running speed and stress. Miao Honglun<sup>[5]</sup> simplified the vehicle as a 1/4 2-DOF model and calculated the modal of the vehicle. Chen Enli<sup>[6]</sup> et al. designed and made a 2-DOF vehicle model, and studied the inherent vibration characteristics of the vehicle. At present, it is the only model test method in China to study the 2-DOF vehicle model.

To sum up, this paper designs a 7-DOF vehicle model, studies the modal of the model by means of mathematical analysis and experimental analysis, and proves the correctness of the design of the 7-DOF vehicle model.

### II. Modal analysis of 7-DOF vehicle model

In the modal analysis of the 7-DOF vehicle model, the centroid position of the model body is mainly studied. The four-wheel suspension of the vehicle adopts the same stiffness spring and damper and is in the same plane, ignoring the vibration of the vehicle in the roll and pitch directions, so the 7-DOF model can be regarded as a dual-mass 2-DOF model for modal analysis. As shown in Figure 1-2.

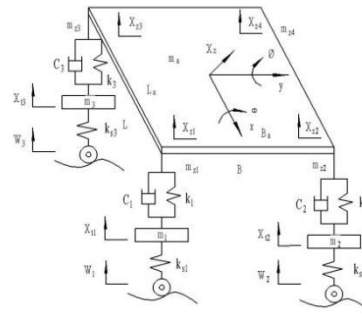

Fig 1: 7-DOF vehicle model

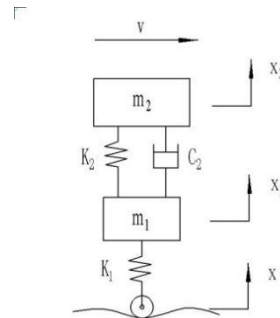

Fig 2: 2-DOF vehicle model

The four wheels and suspension of the model are regarded as a whole, and the dynamic equation established according to Newton's second law is as follows:

$$\begin{cases} M_1 \ddot{x}_1 = -K_1(x_1 - x_0) + K_2(x_2 - x_1) + C_2(\dot{x}_2 - \dot{x}_1) \\ M_2 \ddot{x}_2 = -K_2(x_2 - x_1) - C_2(\dot{x}_2 - \dot{x}_1) \end{cases} \quad (1)$$

$M_1$  is the total mass of four wheels,  $M_2$  is the body mass,  $K_1$  is the total stiffness of four wheels,  $K_2$  is the total stiffness of suspension and  $C_2$  is the total damping of suspension.

When the road input is 0 and the suspension damping is 0, the undamped vibration differential equation of the system can be obtained as follows:

$$\begin{cases} M_1 \ddot{x}_1 = -K_1(x_1 - x_0) + K_2(x_2 - x_1) \\ M_2 \ddot{x}_2 = -K_2(x_2 - x_1) \end{cases} \quad (2)$$

As  $M_1$  and  $M_2$  are mutually coupled, if  $M_1$  is constrained. That is,  $M_2$  will do single-degree-of-freedom undamped vibration, with inherent frequency  $\omega_0 = \sqrt{K_2/m_2}$ . Therefore, if  $M_2$  is constrained, that is  $x_2=0$ ,  $M_1$  will do single-degree-of-freedom undamped vibration, with inherent frequency  $\omega_i = \sqrt{(K_1 + K_2)/m_1}$ . In which,  $\omega_0$  and  $\omega_i$  are the partial frequency when only one mass system vibrates in a two-mass 2-DOF system, that is, offset frequency.

When the system undergoes undamped vibration, assuming that the vehicle body and the wheels do simple harmonic vibration at the same frequency  $\omega$  and phase angle  $\varphi$ , and the amplitude is  $x_3$  and  $x_4$ , the solution is:

$$x_1 = x_3 e^{j(\omega t + \varphi)} \quad (3)$$

$$x_2 = x_4 e^{j(\omega t + \varphi)} \quad (4)$$

Bring formulas (3) and (4) into undamped motion equation, formula (2), to get:

$$\omega_{1,2}^2 = \frac{1}{2}(\omega_1^2 + \omega_0^2) \pm \sqrt{\frac{1}{4}(\omega_1^2 + \omega_0^2)^2 - \frac{K_1 K_2}{M_1 M_2}} \quad (5)$$

Formula (5) is the frequency equation or characteristic equation of the system, in which two roots are the main frequencies  $\omega_1$  and  $\omega_2$  of the two-mass 2-DOF system.

### III. Calculation of basic parameters of 7-DOF vehicle model

To make the model test closer to the real vehicle test, more correct and more universal and reduce the test error, the parameters of the model should be closer to those of the real vehicle. Dimension analysis method is the foundation of physics model theory. This paper uses dimension analysis method to design the vehicle model, which can minimize the error of model test [7].

Select physical quantity dimensional mass  $m$ , damping coefficient  $c$ , suspension stiffness  $k$ , displacement  $x$ , velocity  $\dot{x}$  and acceleration  $\ddot{x}$ , and list the form of power product of physical quantity parameters according to dimensional homogeneous rule:

$$A = m^{a_1} k^{a_2} c^{a_3} x^{a_4} \dot{x}^{a_5} \ddot{x}^{a_6} \quad (6)$$

According to the dimensional homogeneity rule and formula (6), the dimensional matrix can be obtained as shown in Table 1.

Table 1 Model dimension matrix						
	$m$	$c$	$k$	$x$	$\dot{x}$	$\ddot{x}$
M	1	1	1	0	0	0
L	0	0	0	1	1	1
T	0	-2	-1	0	-1	-2

According to the dimensional matrix, formula (6) can be transformed into homogeneous equations.

$$A^T = \begin{bmatrix} 1 & 1 & 1 & 0 & 0 & 0 \\ 0 & 0 & 0 & 1 & 1 & 1 \\ 0 & -2 & -1 & 0 & -1 & -2 \end{bmatrix} \quad (7)$$

By solving the homogeneous linear equations  $A^T \beta = 0$ , three basic solution vectors of the matrix can be obtained. According to the  $\Pi$  theorem, dimensionless quantity can be obtained as follows:

$$\begin{cases} \Pi_1 = mkc^{-2} \\ \Pi_2 = kxc^{-2}\ddot{x} \\ \Pi_3 = kxc^{-1}\ddot{x} \end{cases} \quad (8)$$

$\Pi_1, \Pi_2, \Pi_3$  form the function

$$\phi(\Pi_1, \Pi_2, \Pi_3) = 0 \quad (9)$$

Formula (9) is the similar model.

Choose the automobile parameters,  $m = 1350\text{kg}$ ,  $c = 640\text{kN} \cdot \text{s} \cdot \text{m}^{-1}$ , and  $k = 780\text{kN} / \text{m}$ , in reference [8]. The numerical value corresponding to the model is obtained according to the dimensional theoretical formula.

#### IV. Design of 7-DOF vehicle model

7-DOF vehicle model consists of four sets of directional wheels, vehicle body and suspension system. The length and width of the vehicle body are 300mm and 250mm respectively. The four groups of wheels are directional wheels, with a diameter of 100mm, a rolling radius of 310mm and a front-rear track of 150mm. This paper mainly studies and analyzes the vertical movement of vehicles. The springs are installed on bolts in parallel as suspension stiffness, which can ensure the stability of wheels and avoid tilting and twisting of wheels. A damper is installed in the middle of two parallel bolts as suspension damping. See Figure 3.

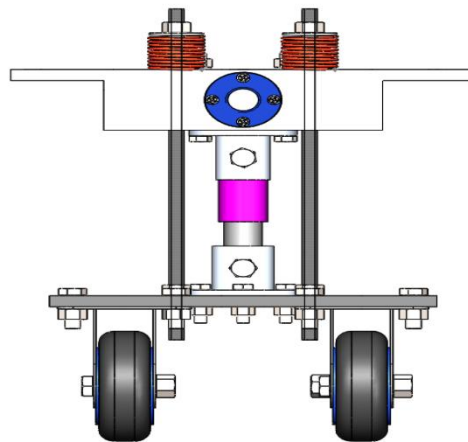

(a) Design drawing of vehicle model (transmission part)

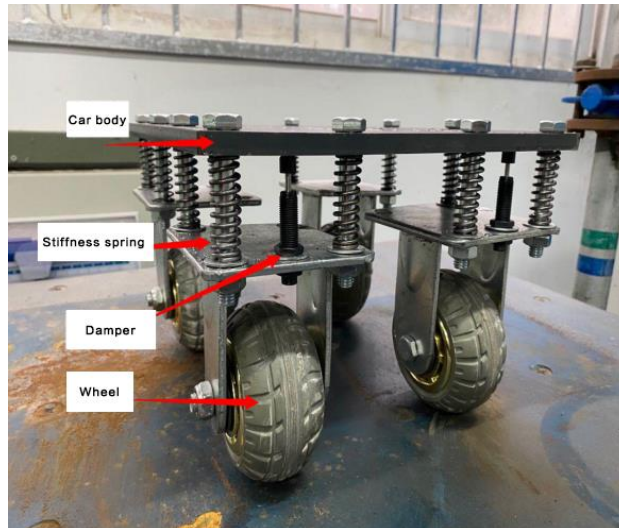

(b) Physical drawings of vehicle models  
Fig 3: 7-DOF vehicle model

#### IV. Modal test of 7-DOF vehicle model

The modal test of vehicle model requires to use shaking table for frequency sweep analysis on the model. In this paper, TP-100 vibration table is selected for the test. It outputs sine wave vibration waveform, with vertical vibration mode. Its sweep frequency range can be controlled by computer. The instrument has a control precision of 0.01Hz, an amplitude range of 0-5mm, a maximum acceleration of 20g, and a maximum test load of 100Kg. The model CT1005LC acceleration sensor is adopted, with a sensor frequency range of 0.5-8000Hz, and a maximum measured acceleration of 100g. The sensitivity and range accuracy of the sensor meet the test requirements. The sensor is shown in Figure 4, and the shaking table test is shown in Figure 5.



Fig 4: CT1005LC acceleration sensor



Fig 5: Shaking table test diagram

Modal test steps of 7-DOF vehicle are as follows:

- (1) Install the vehicle model on the vibration table. Since the test aims to analyze the acceleration at the center of mass of the vehicle, the acceleration sensor is installed at the center of mass of the vehicle body.
- (2) Connect the acceleration sensor with uT8908FRS-TEDS network distributed acquisition and analysis system, and observe the waveform by computer DASP software.
- (3) Test the 7-DOF vehicle model under three working conditions, namely, undamped test, standard damping test and overdamping test. The AC1210 damping designed in section 3 of this chapter is used for standard damping test, and the AD1410 adjustable damper is used for over-damping test, as shown in Table 2. The damping ratio shown in table is damping ratio of single wheel suspension.

Table 2 Three working conditions

Working condition	Suspension spring	Suspension damping	Damping ratio
Working condition 1	Yes	No	0
Working condition 2	Yes	Standard damping	$0.078N \cdot s / mm^2$
Working condition 3	Yes	Overdamping	$0.78N \cdot s / mm^2$

(4) The parameters of shaking table are set by computer. The vibration table excitation frequency amplitude is 5mm. The excitation acceleration is 0.5g, and the range is 0.5Hz to 25Hz <sup>[9]</sup>. The vehicle models under three working conditions are tested for frequency sweep.

(5) Record the test data. The acceleration time domains at the center of mass of the vehicle model under three working conditions are respectively shown in Figure 6-8, and the acceleration frequency domain diagrams are shown in Figure 9-11.

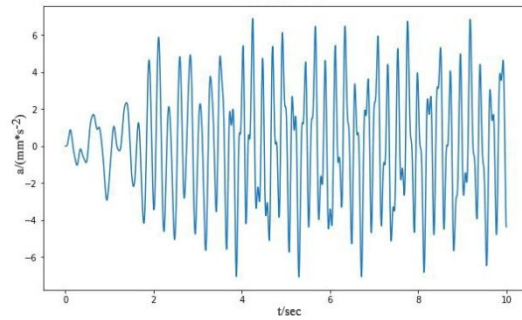

Fig 6: Time domain diagram of working condition 1

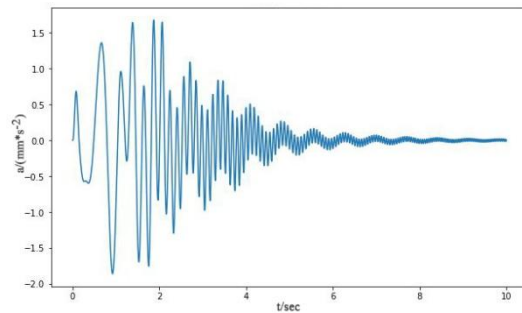

Fig 7: Time domain diagram of working condition 2

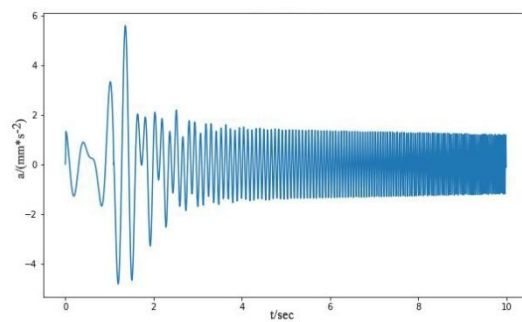

Fig 8: Time domain diagram of working condition 3

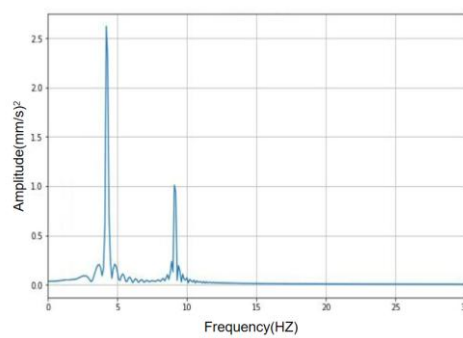

Fig 9: Frequency domain diagram of working condition 1

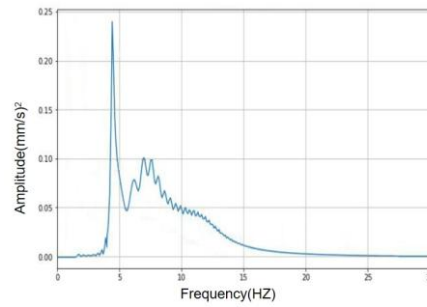

Fig 10: Frequency domain diagram of working condition 2

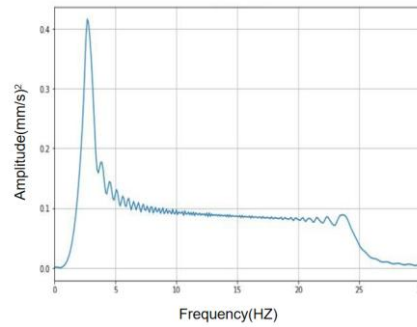

Fig 11: Frequency domain diagram of working condition 3

According to the literature [9], the random vibration excitation range of pavement is 0.5-25Hz, so only the model modes in this frequency range need to be analyzed, and the high-order modes of the model can be ignored.

The undamped first-order and second-order natural frequencies of 7-DOF vehicle model are calculated by MATLAB software, which are 4.24Hz and 9.18Hz respectively. The frequency domain diagram is shown in Figure 12.

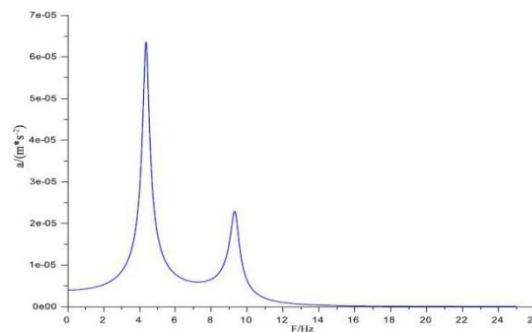

Fig 12: Frequency domain diagram of vehicle inherent frequency simulation

Based on the above test data and simulation data, it is summarized as Table 3.

Table 3 Test results under various working conditions

Working condition	Suspension damping	First order inherent frequency/Hz	Second order inherent frequency/Hz	First order error	Second order error
Numerical simulation	No damping	4.24	9.18	-	-
Working condition 1	No damping	4.13	8.94	2.1%	2.3%
Working	Standard damping	4.21	6.88	0.7%	22%



condition 2				
Working condition 3	Overdamping	3.47	16%	-

Because the numerical simulation method is based on the undamped state of the model, the inherent frequency error of the model is within 2.3% compared with the case 1, which proves that the design of the model is reasonable.

Comparing working condition 1 with working condition 2, the inherent frequency does not change greatly after adding standard damping. Comparing Figure 9 with Figure 10, it can be found that the acceleration value of working condition 2 is obviously reduced, which proves that the vibration of the center of mass of the vehicle is suppressed under standard damping, which greatly improves the driving stability and driving comfort .

In case 3, the first-order inherent frequency is reduced by 15.9% and the second-order inherent frequency is suppressed by damping.

## VI. Conclusion

In this paper, based on the motion differential equation of the 7-DOF vehicle model, the modal equation of the model is derived, and the inherent frequency of the model is solved. The parameters of 7-DOF vehicle model are determined by dimensional analysis method, and the physical model of 7-DOF vehicle is designed and manufactured. The modal test of vehicle model is carried out by using shaking table, and the modal and amplitude-frequency characteristics of vehicle under different working conditions are determined by frequency sweep vibration test. Comparing the test results with the numerical analysis results, the error is small, which proves that the vehicle model design is reasonable and the model algorithm is correct.

## References:

- [1] W.J. Goodrum, D. Cebon. Synthesising spatially repeatable tyre forces from axle load probability distributions. *Proceedings of the Institution of Mechanical Engineers*, 2016, 230(5).
- [2] E.J. OBrien, A. Taheri. Numerical integration approach to the problem of simulating damage in an asphalt pavement. *International Journal of Pavement Engineering*, 2012, 13(4):339-349. DOI:10.1080/10298436.2011.575135.
- [3] E.J. Stone, D. Cebon. Control of semi-active anti-roll systems on heavy vehicles. *Vehicle System Dynamics*, 2010, 48(10):1215-1243. DOI: 10.1080/00423110903427439.
- [4] X.J. Deng. Study on vehicle-ground structure system dynamics. *Journal of Southeast University (Natural Science Edition)*, 2002, (03):474-479.
- [5] H.L. Miao. Experimental study on vehicle-road interaction dynamics based on 2-DOF vehicle model. Shijiazhuang Tiedao University, 2015.
- [6] E.L. Chen, Y.Q. Liu, J.B. Zhao. Experimental study on dynamic response of pavement under moving load. *Journal of Vibration and Shock*, 2014, 33(16):62-67.
- [7] B.H. Sun. Dimensional analysis and application. *Physics and Engineering*, 2016, 26(06):11-20.
- [8] Z.S. Yu. *Automotive Theory*. 5th Edition. Beijing: Mechanical Industry Press, 2009.
- [9] X.H. Shi, X. Jiang, J. Zhao, J.X. Zhai. Study on vehicle-road coupling dynamic load on uneven road surface. *C China Sciencepaper*, 2018, 13(04):408-413.